

選手権男子 本戦

2025年12月10日付ランキング使用

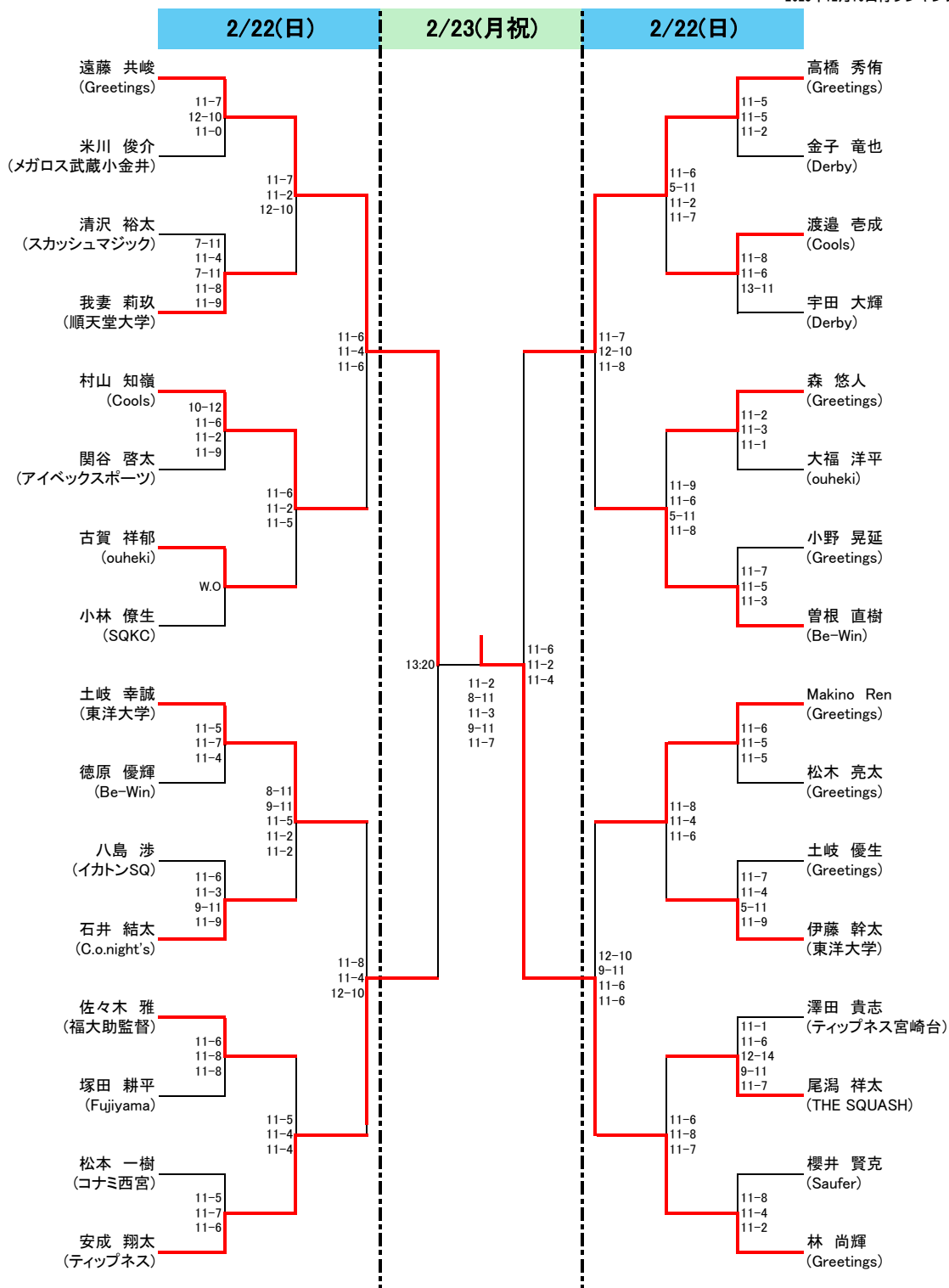

選手権女子 本戦

2025年12月10日付ランキング使用

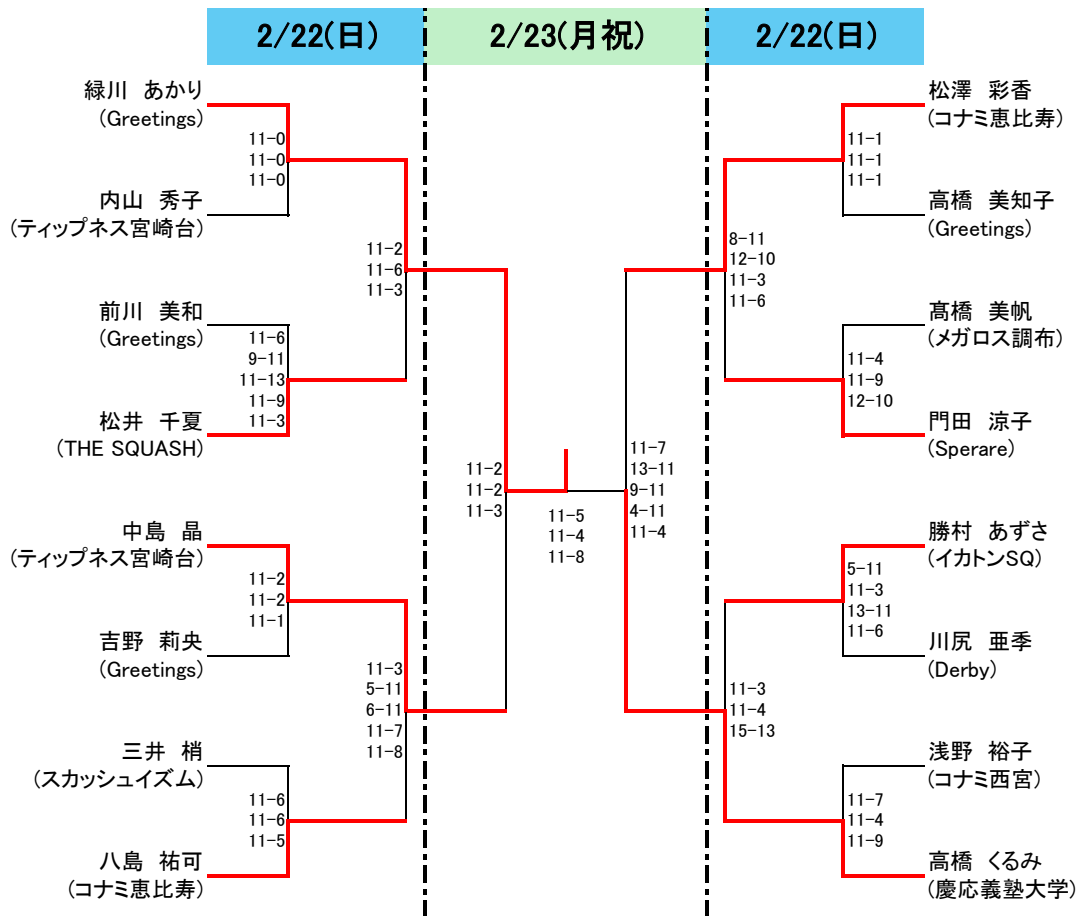

選手権男子予選 2/21(土) 1/2

2025年12月10日付ランキング使用

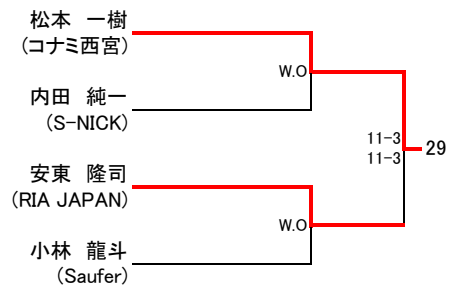
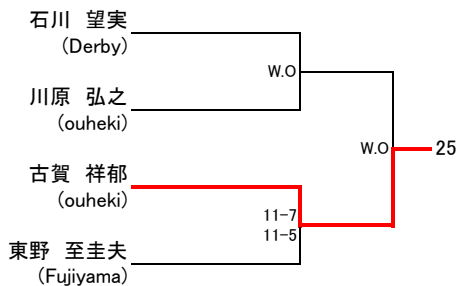
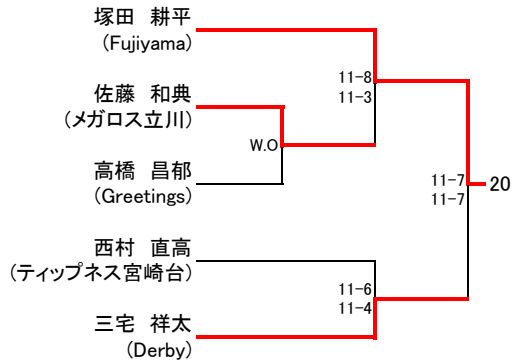
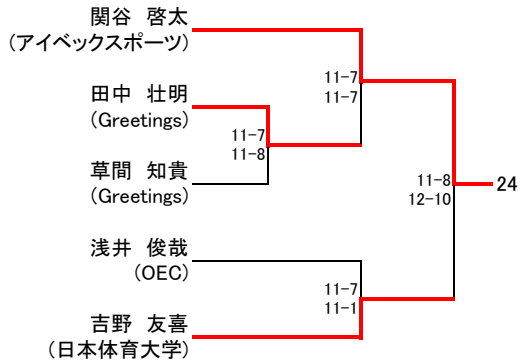
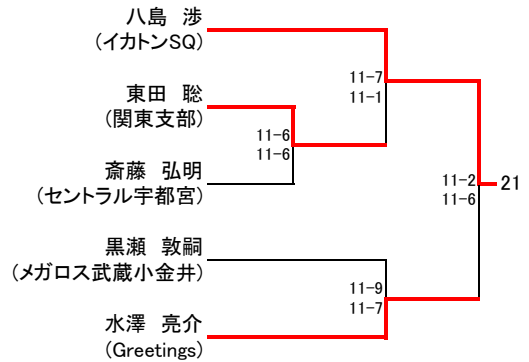
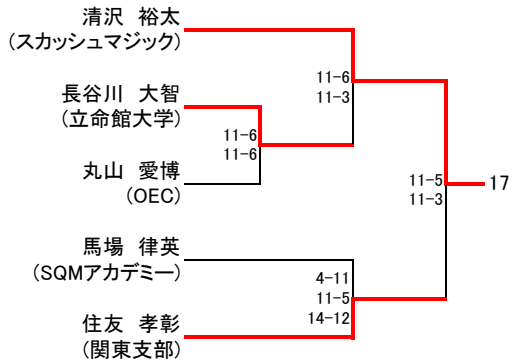
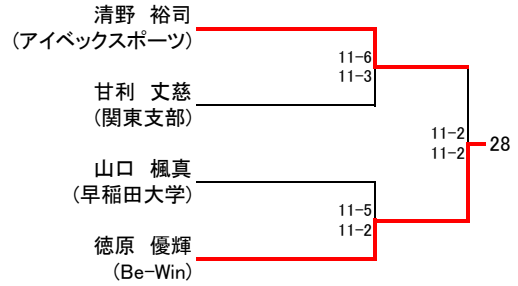
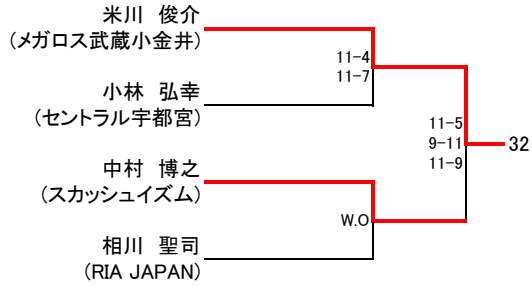



AIDA SEKKEI CHAMPIONSHIPS

Greetings Squash 2026 Winter



選手権男子予選 2/21(土) 2/2

2025年12月10日付ランキング使用

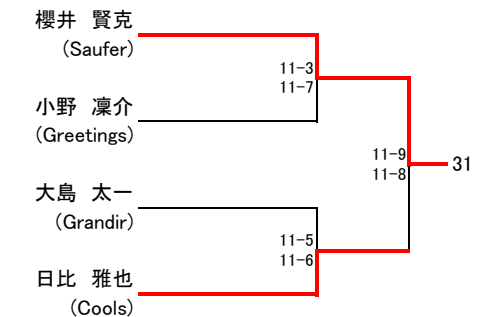
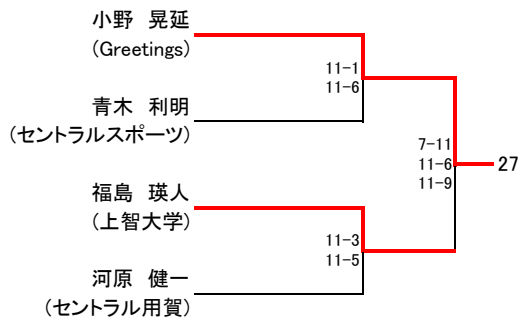
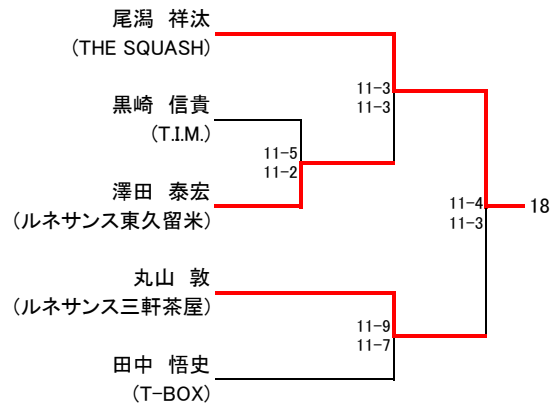
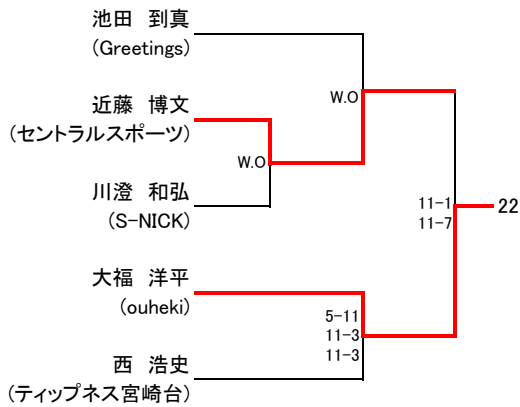
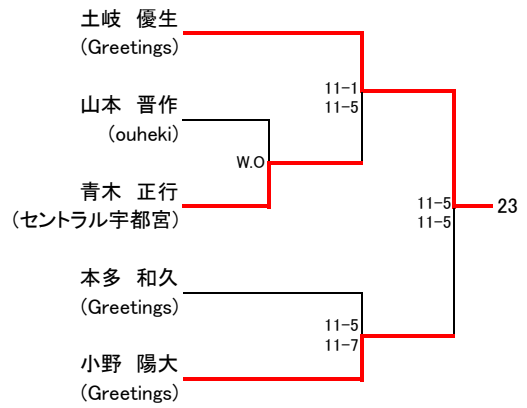
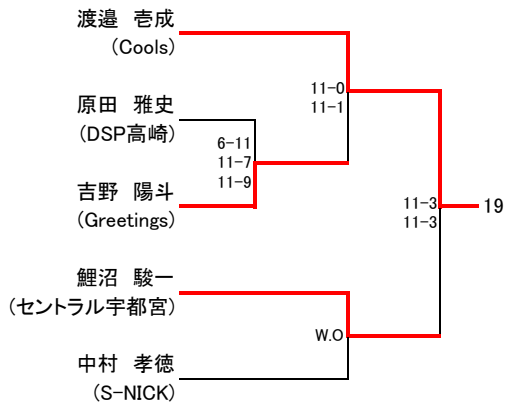
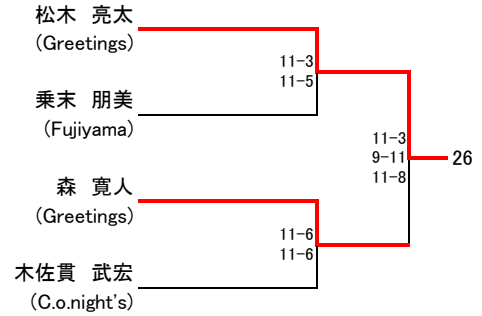
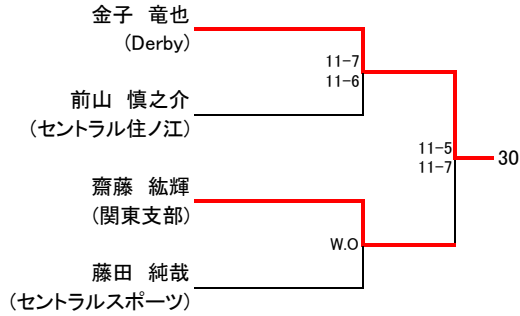

選手権女子予選 2/21(土) 1/2

2025年12月10日付ランキング使用

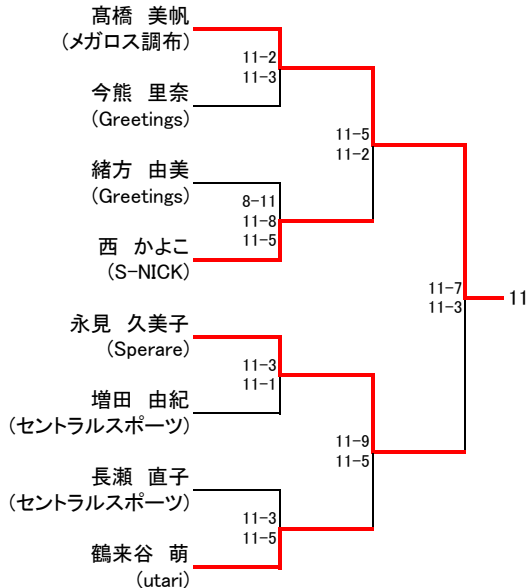
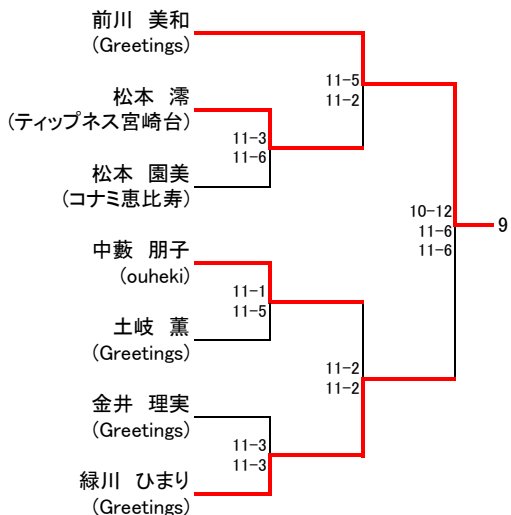
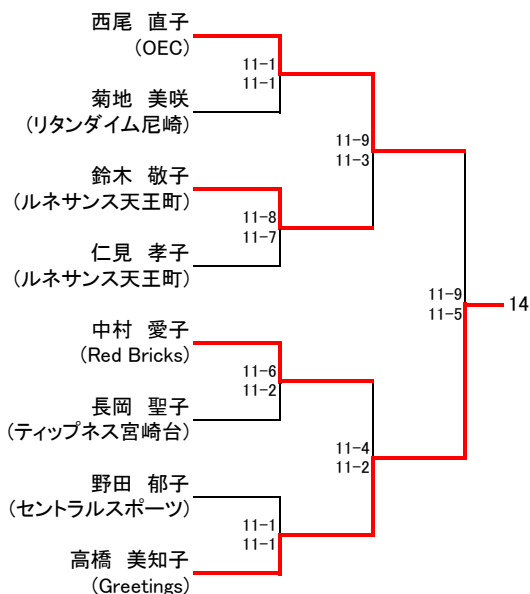
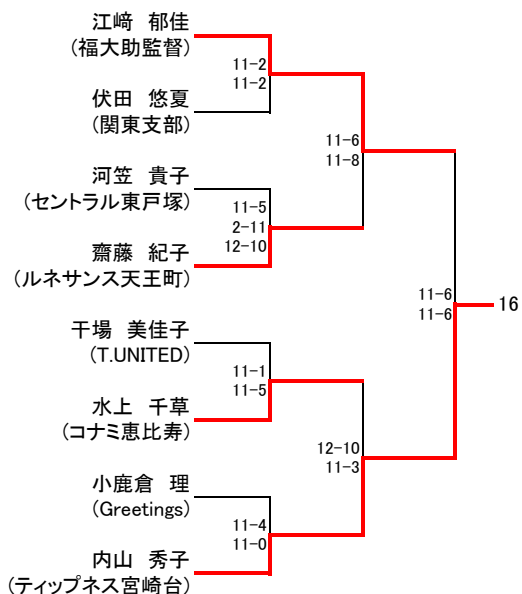



AIDA SEKKEI CHAMPIONSHIPS

Greetings Squash 2026 Winter



選手権女子予選 2/21(土) 2/2

2025年12月10日付ランキング使用

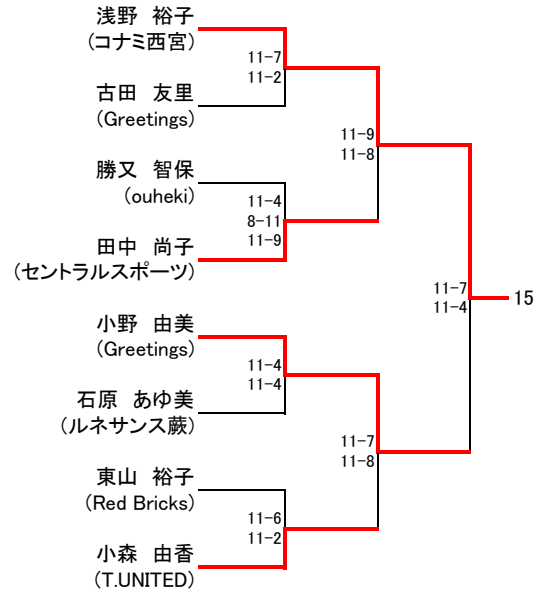
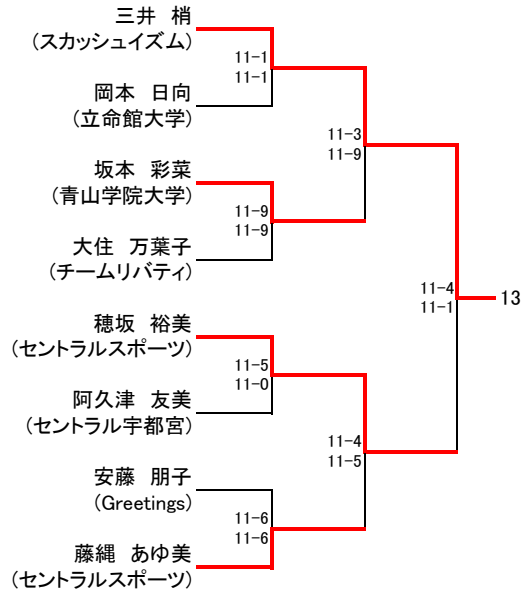
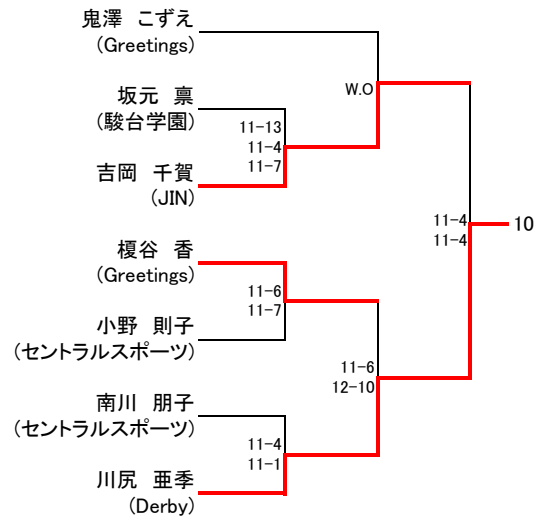
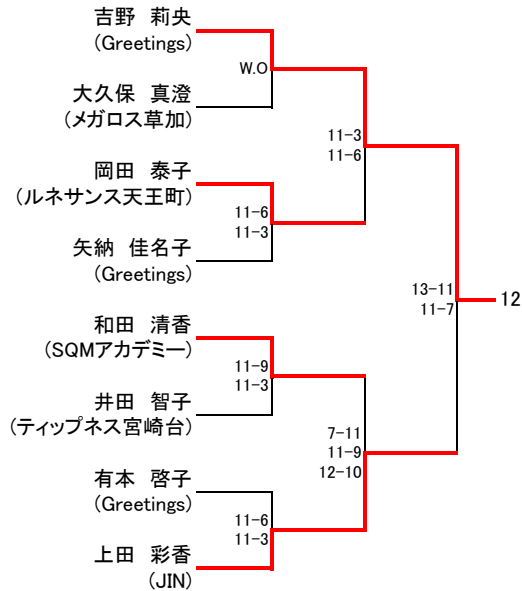

フレンド男子A 2/23(月祝)

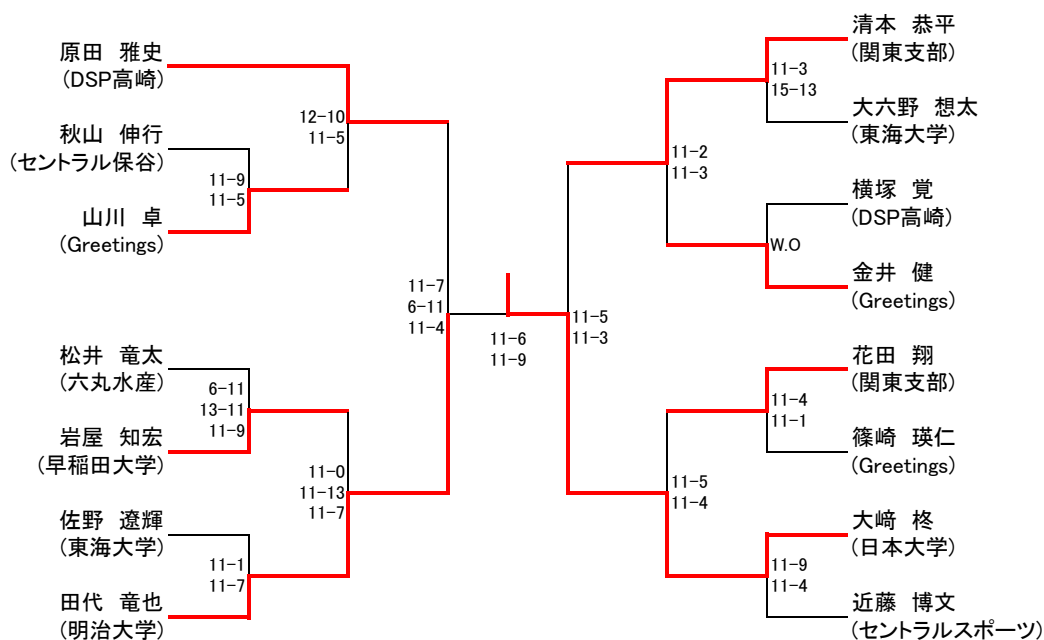



AIDA SEKKEI
CHAMPIONSHIPS
Greetings Squash 2026 Winter



フレンド女子 2/23(月祝)

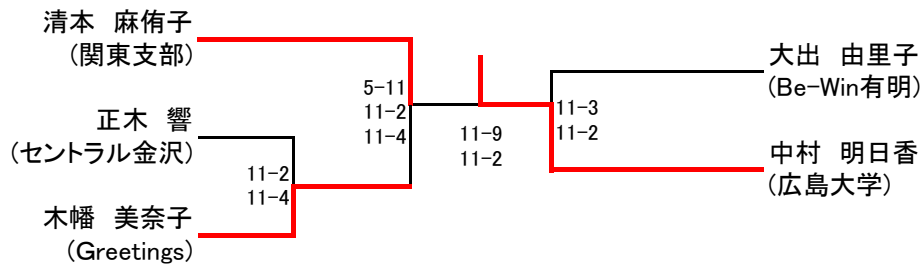

フレンド男子B 2/22(日)

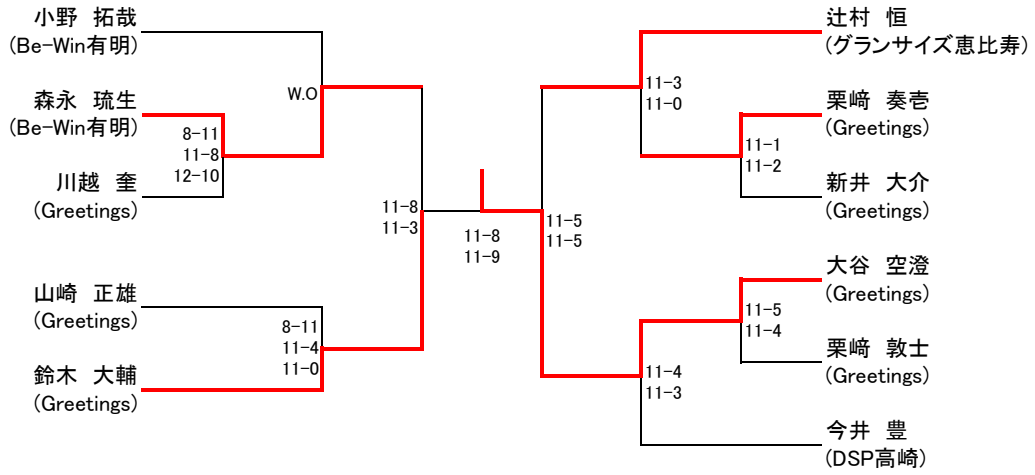



**AIDA SEKKEI
CHAMPIONSHIPS**
Greetings Squash 2026 Winter



小学生6年生以下 2/23(月祝)

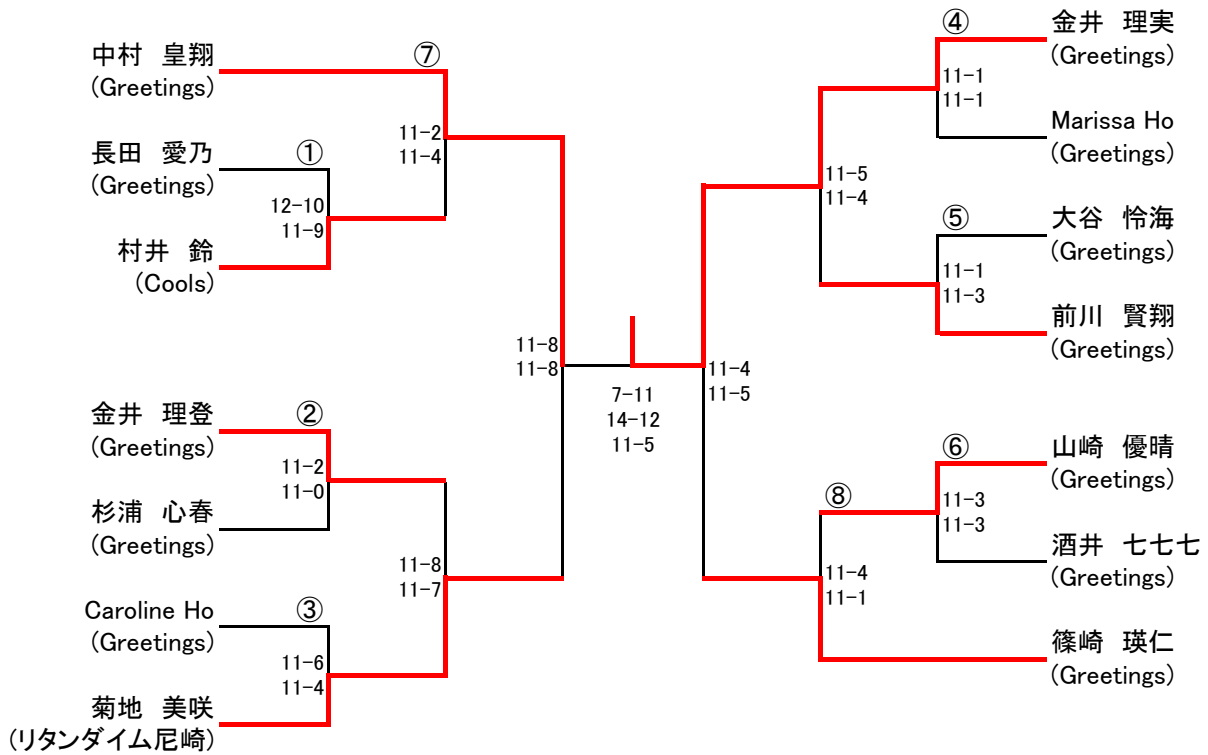

プレート戦

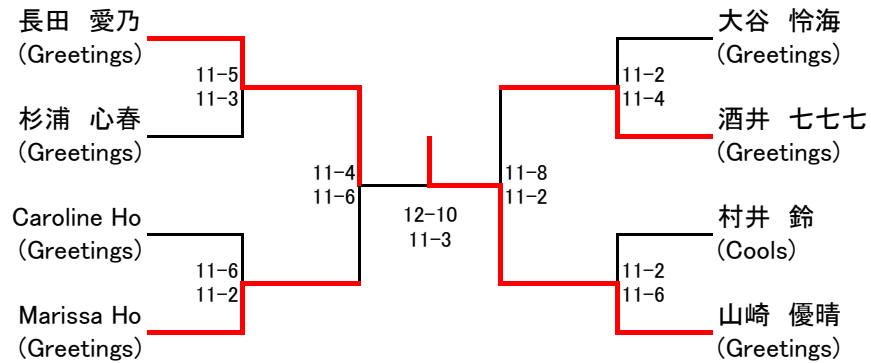



AIDA SEKKEI CHAMPIONSHIPS

Greetings Squash 2026 Winter



小学生4年生以下 2/22(日)

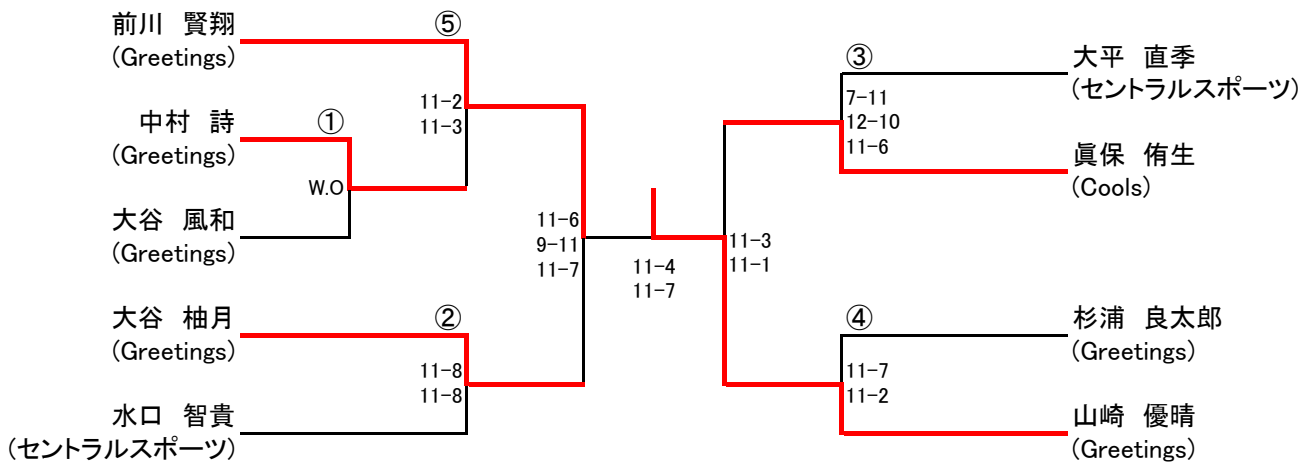

プレート戦

