

選手権男子本戦

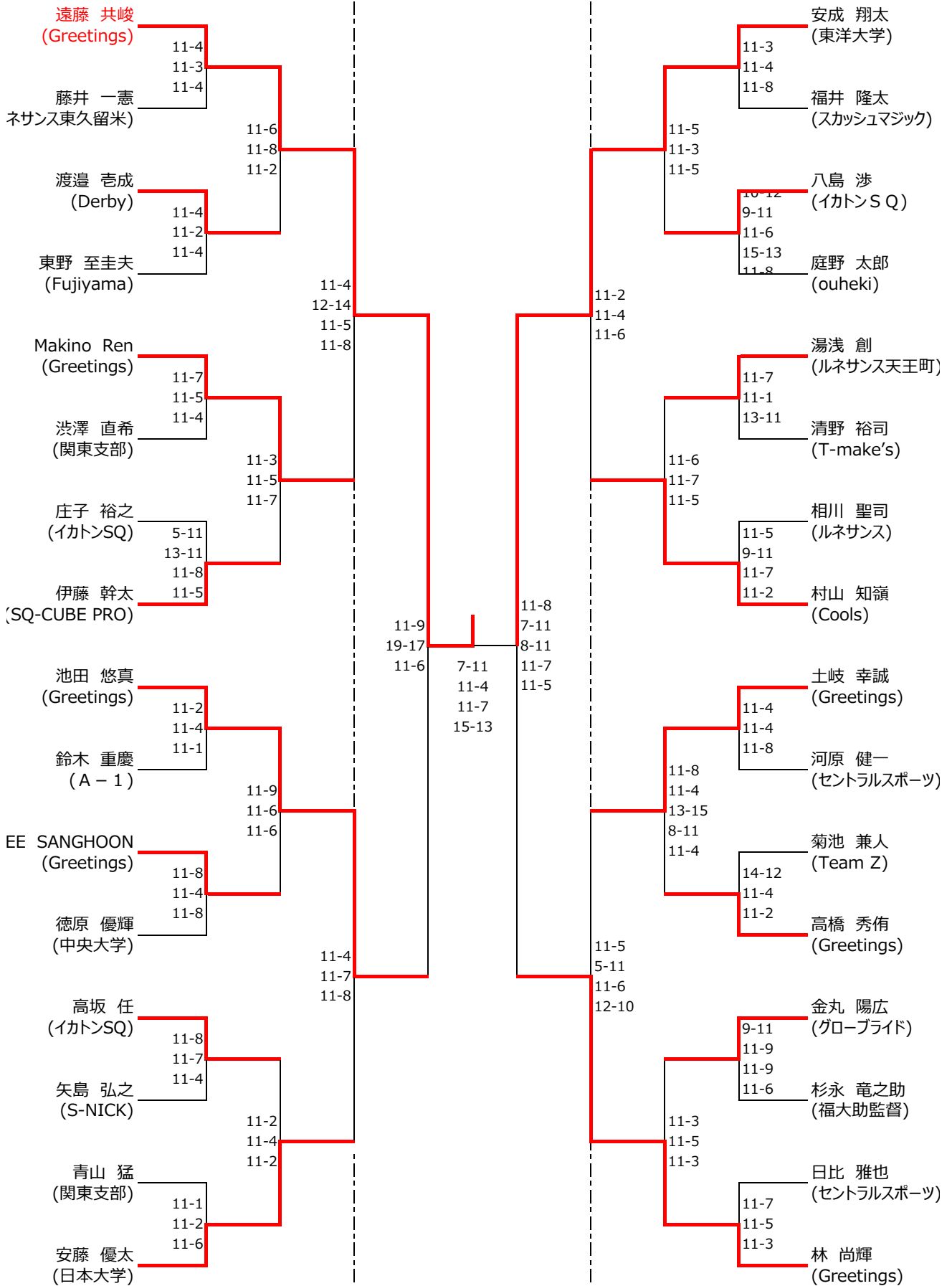

選手権女子本戦

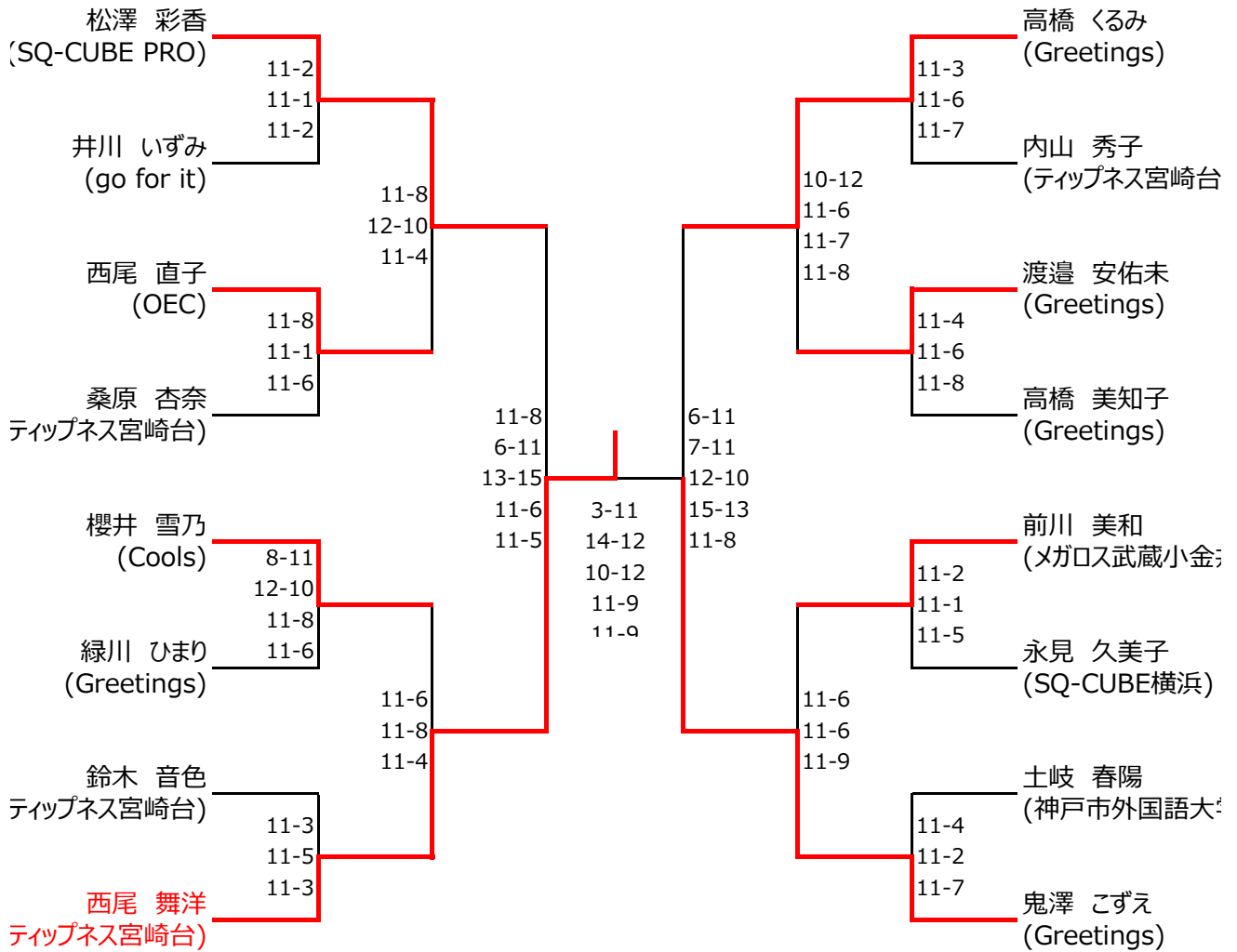

選手権男子予選(1/2)

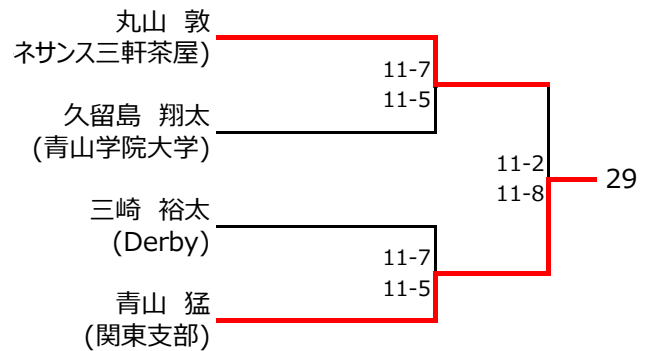
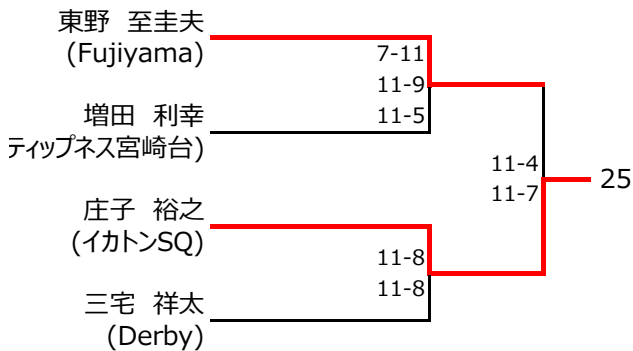
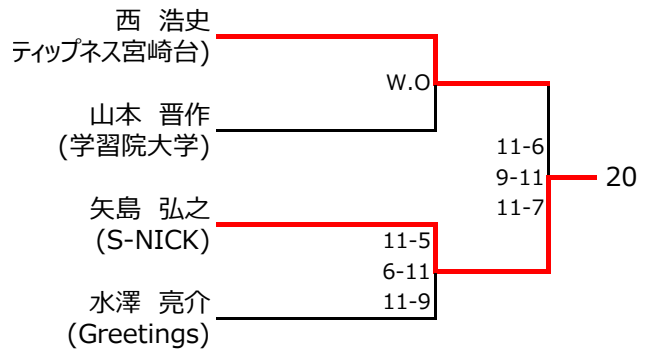
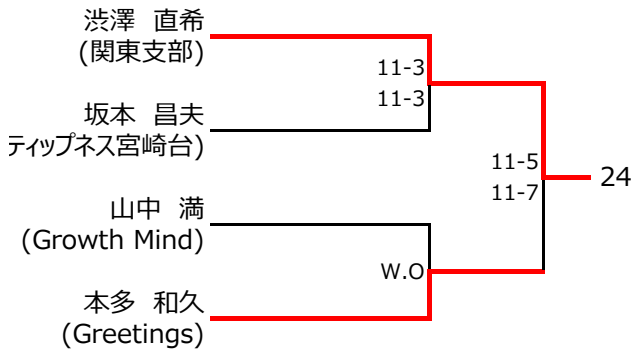
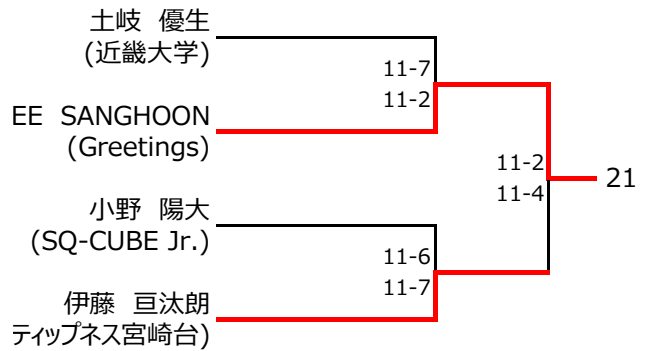
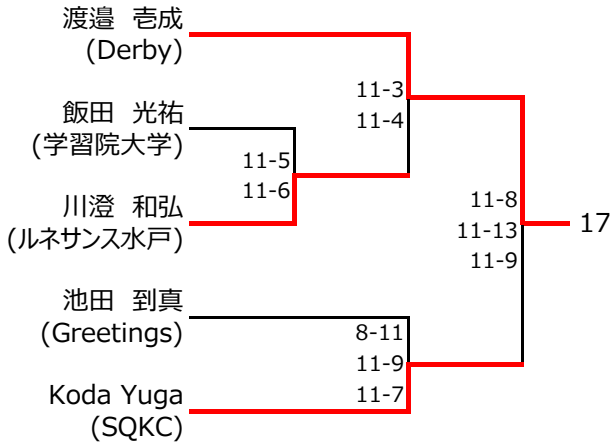
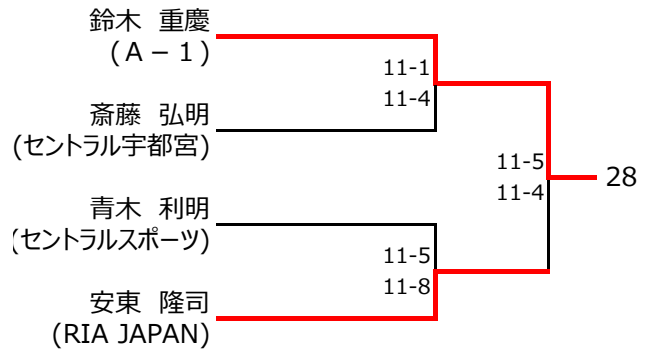
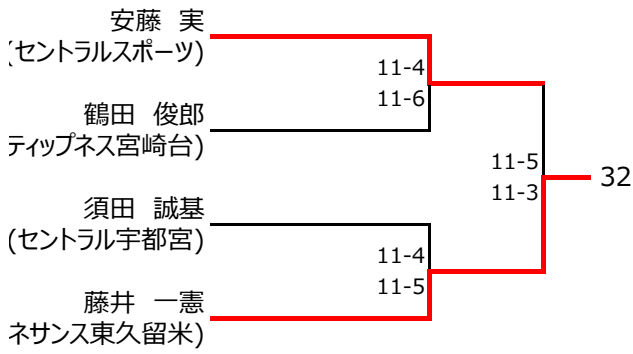

選手権男子予選(2/2)

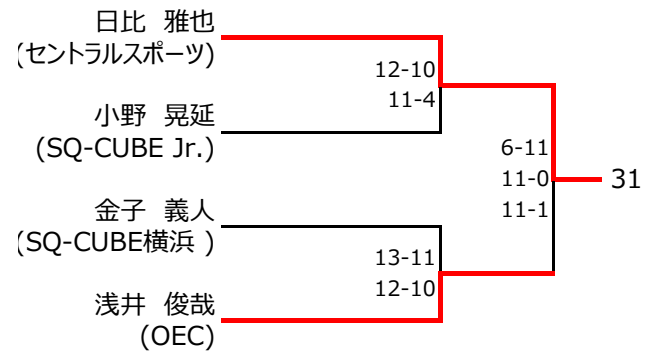
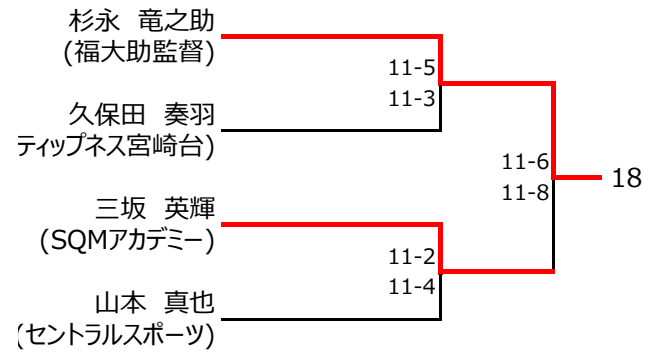
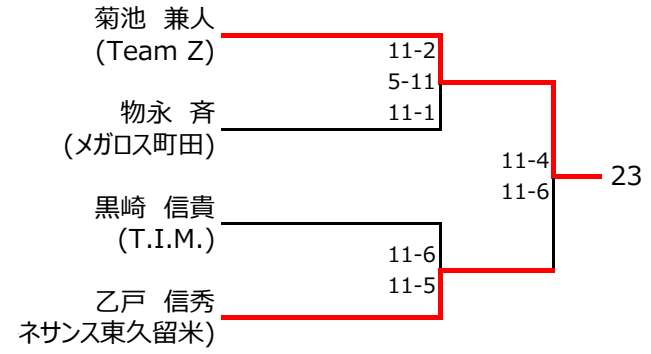
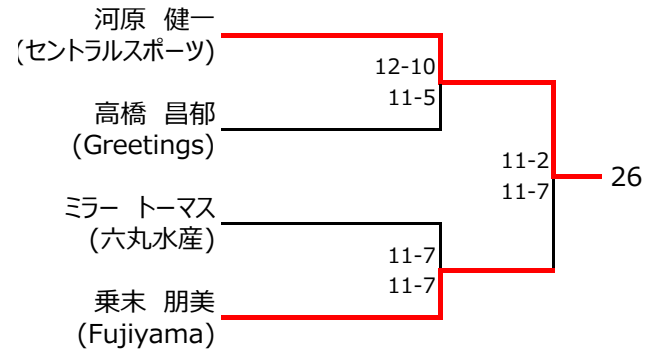
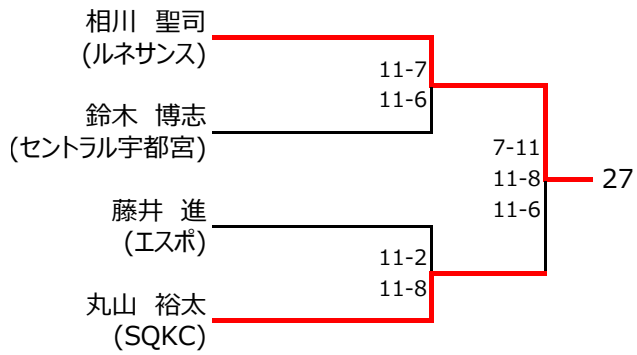
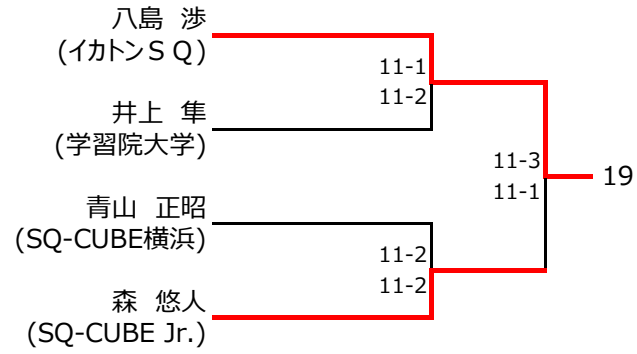
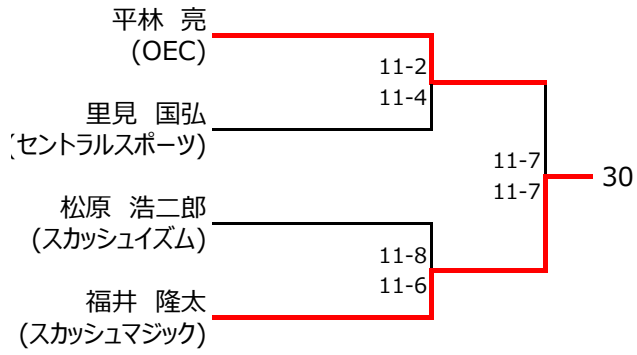

選手権女子予選

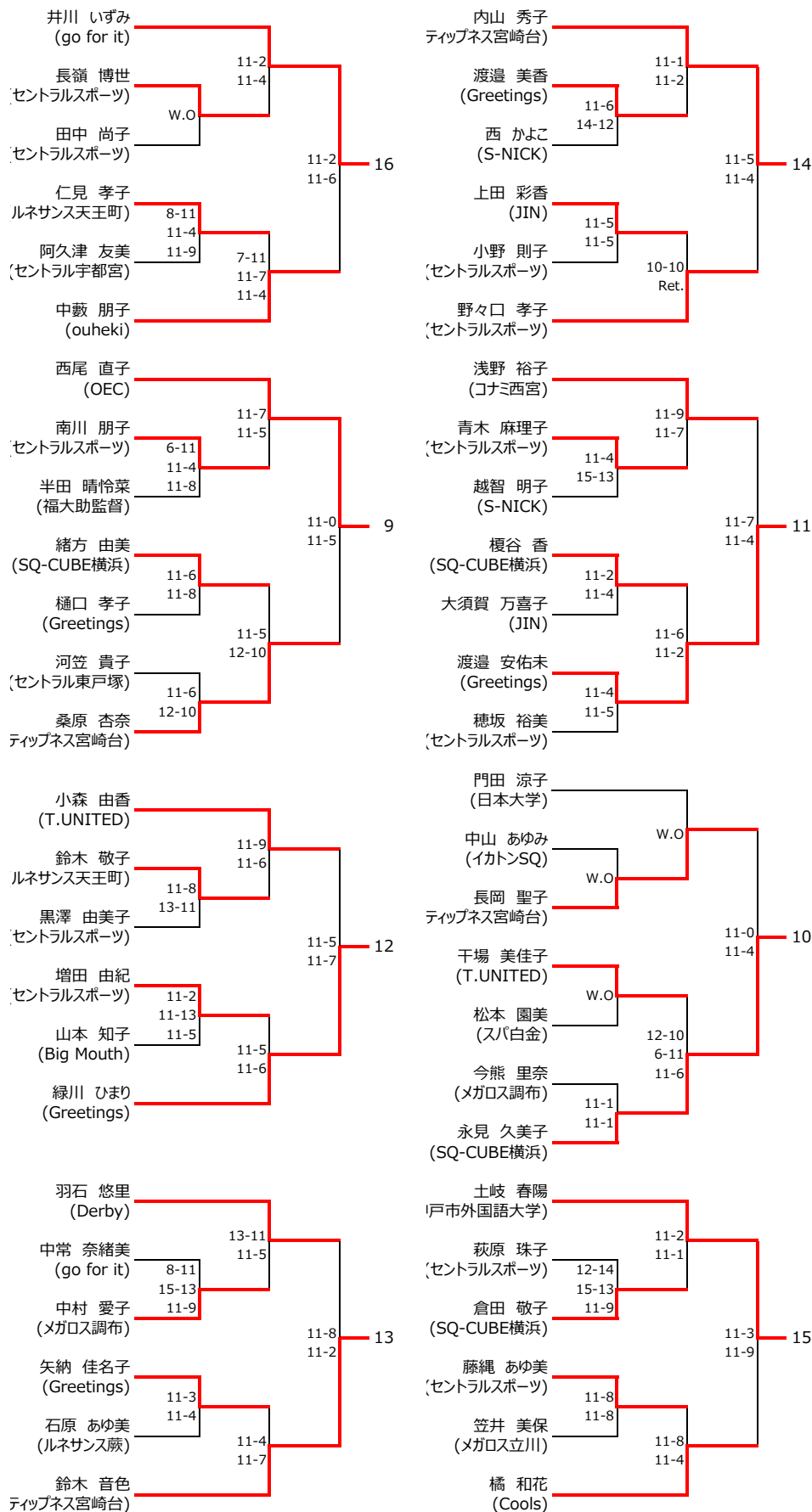

フレンド男子

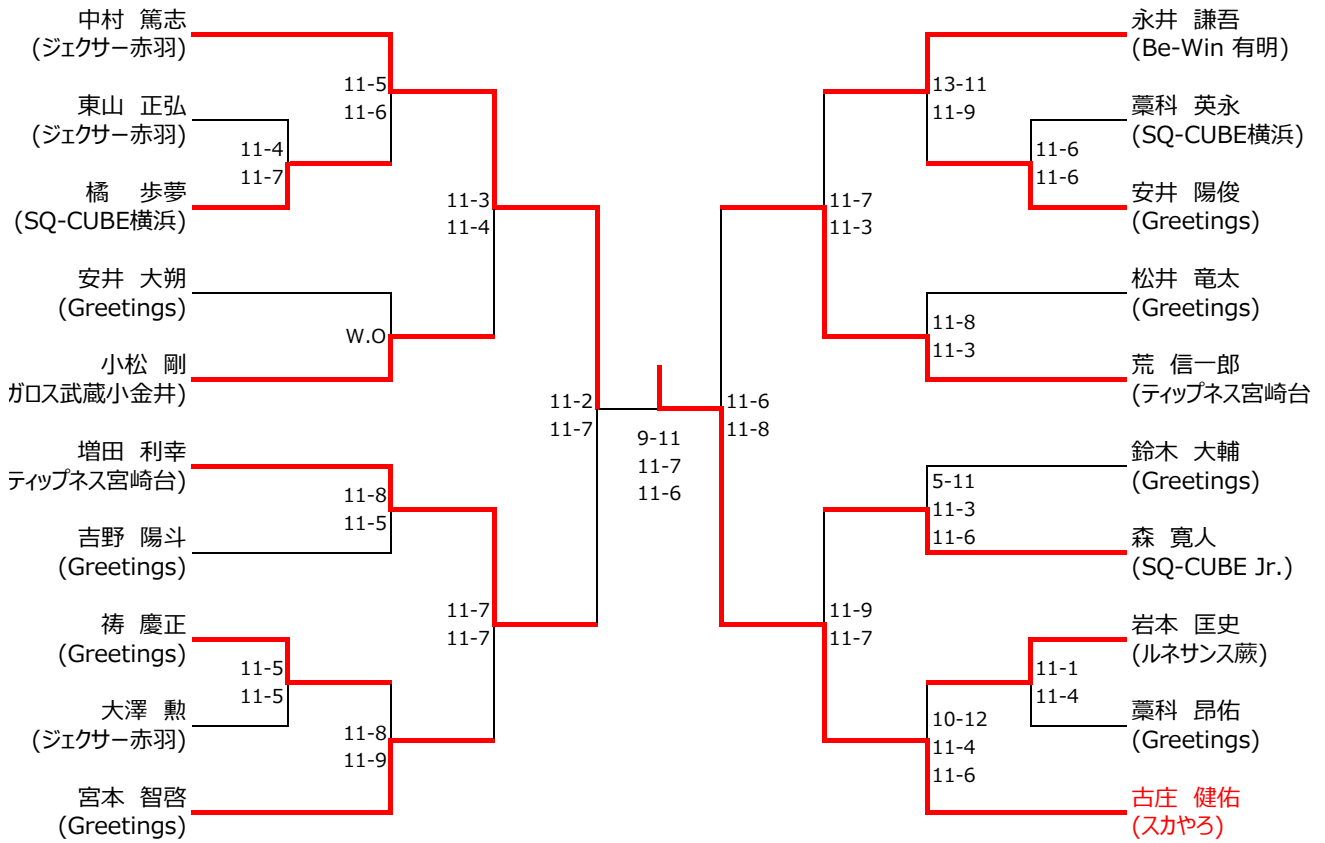

フレンド女子

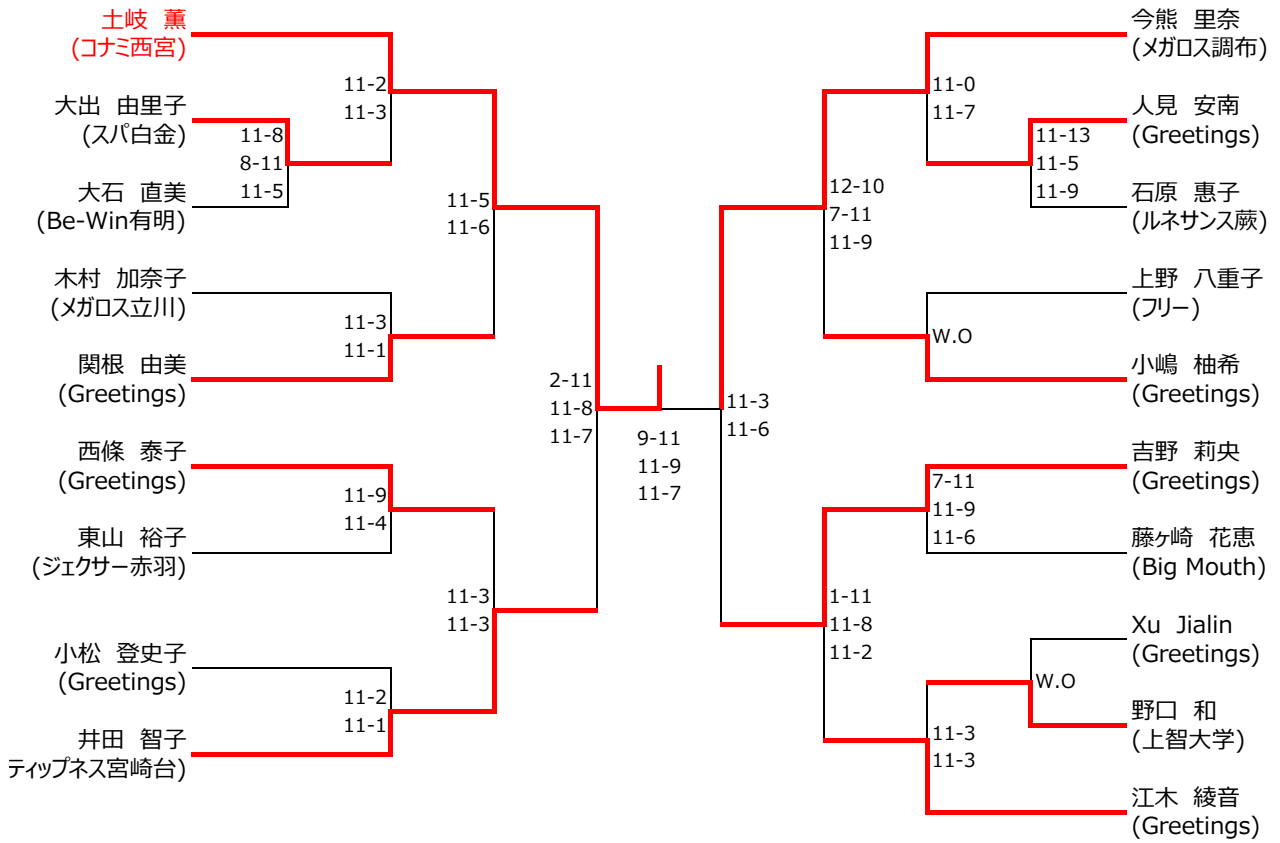

新人男子

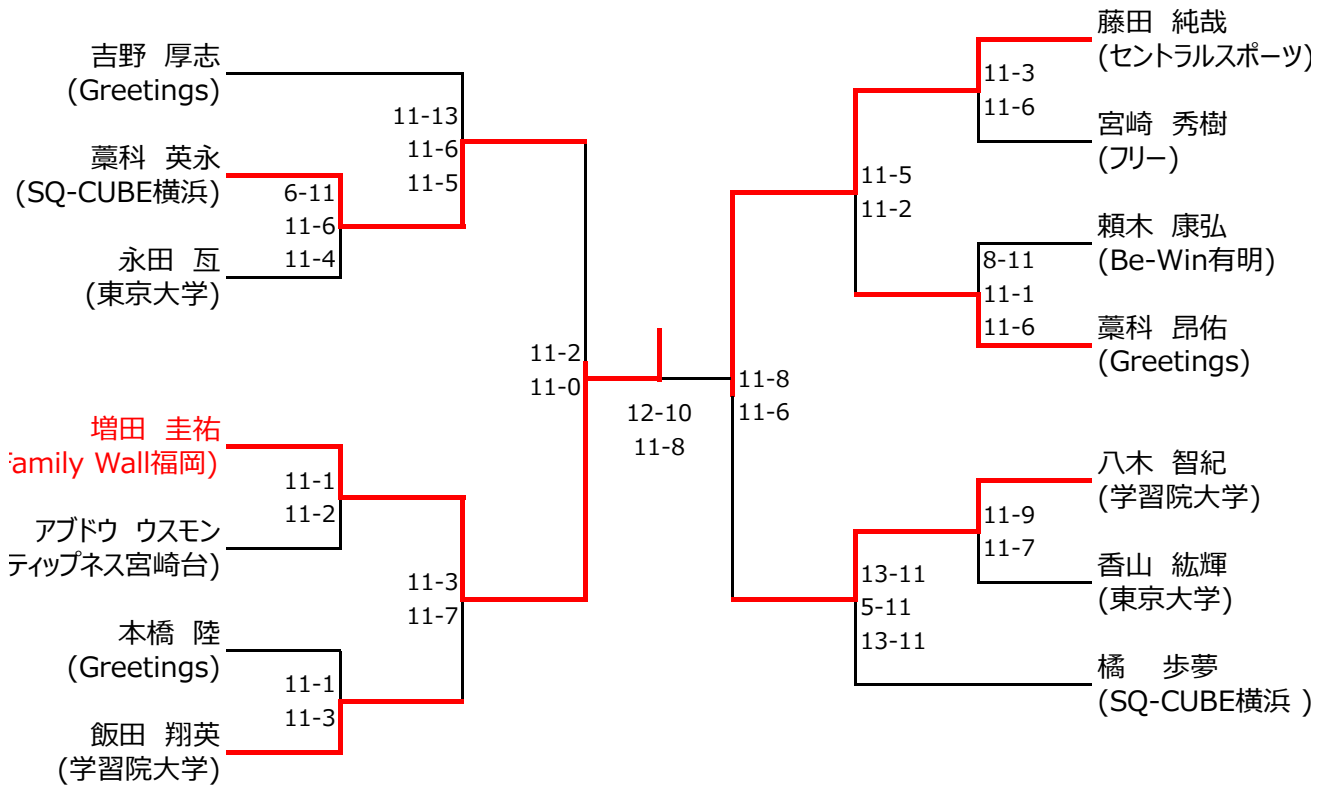



小学5・6年生の部

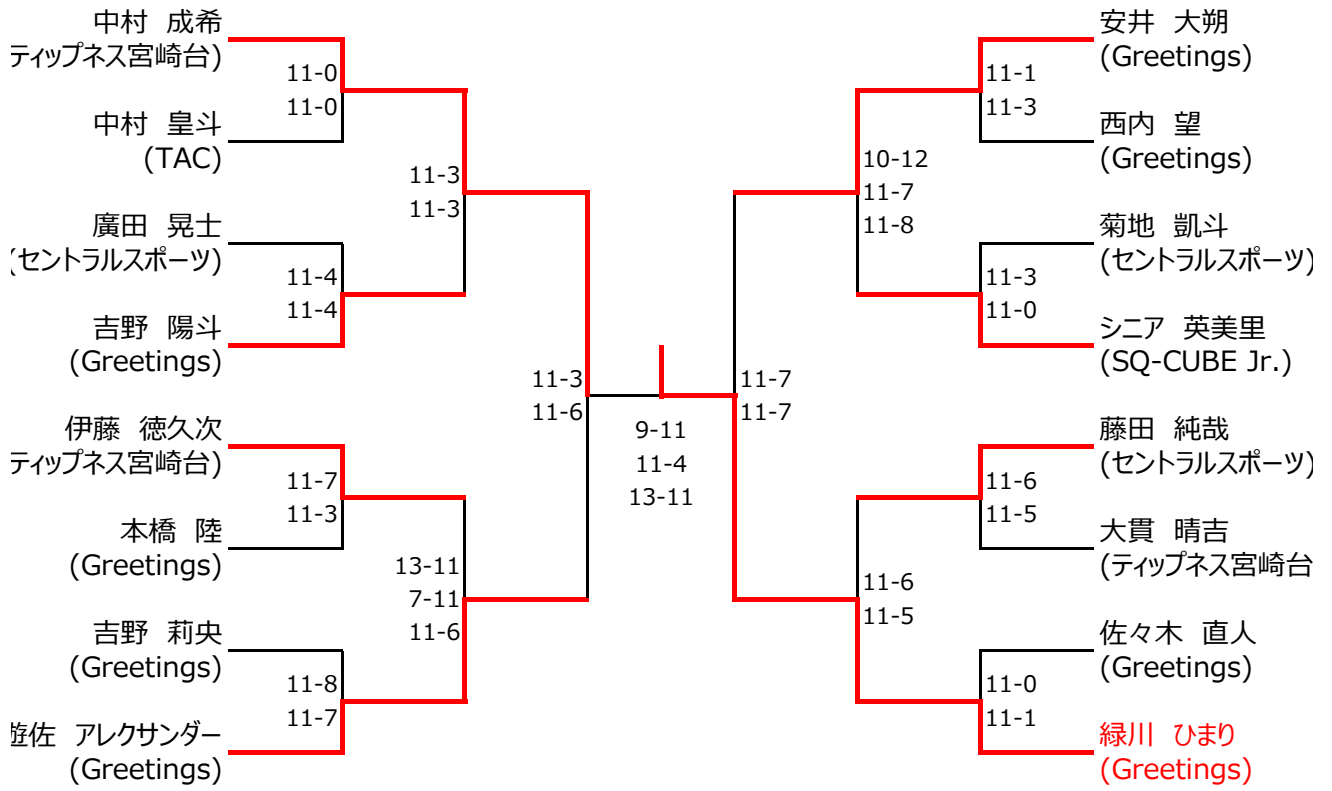

小学4年生以下の部

